

REV. NO		REV. HISTORY	LTR	ECO NO	DATE	APPR'L
DWG	PART					
00	00	INITIAL RELEASE	-	-	-	-

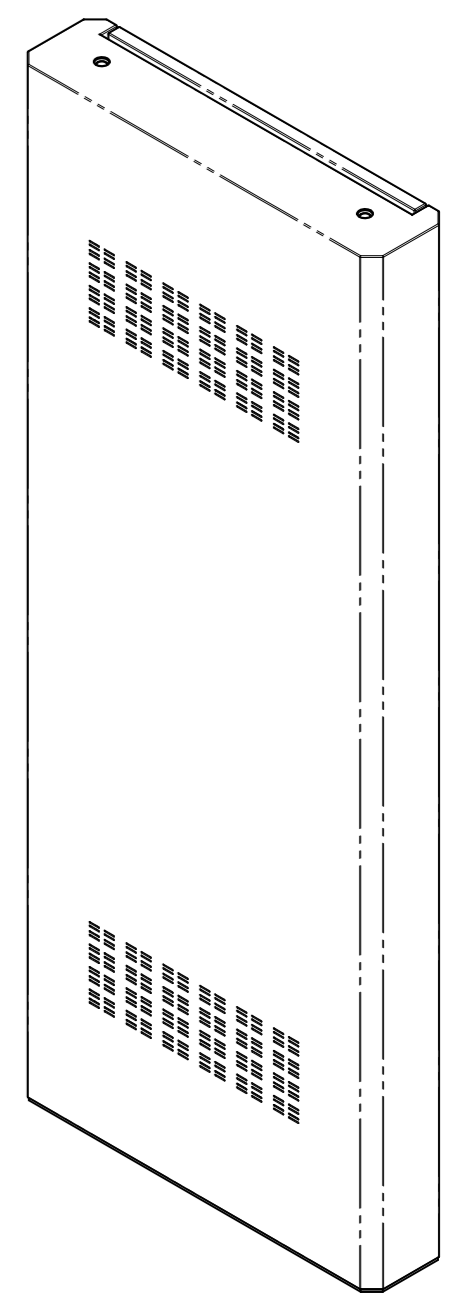

STB BOX Size(Max) : W(280) * H(240) * D(110)

FRONT OPEN VIEW

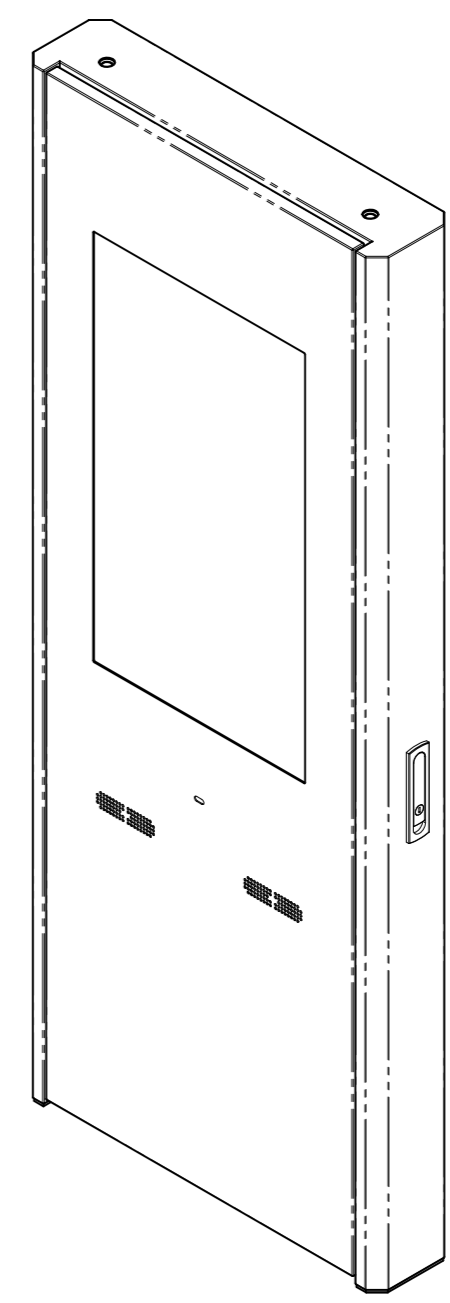
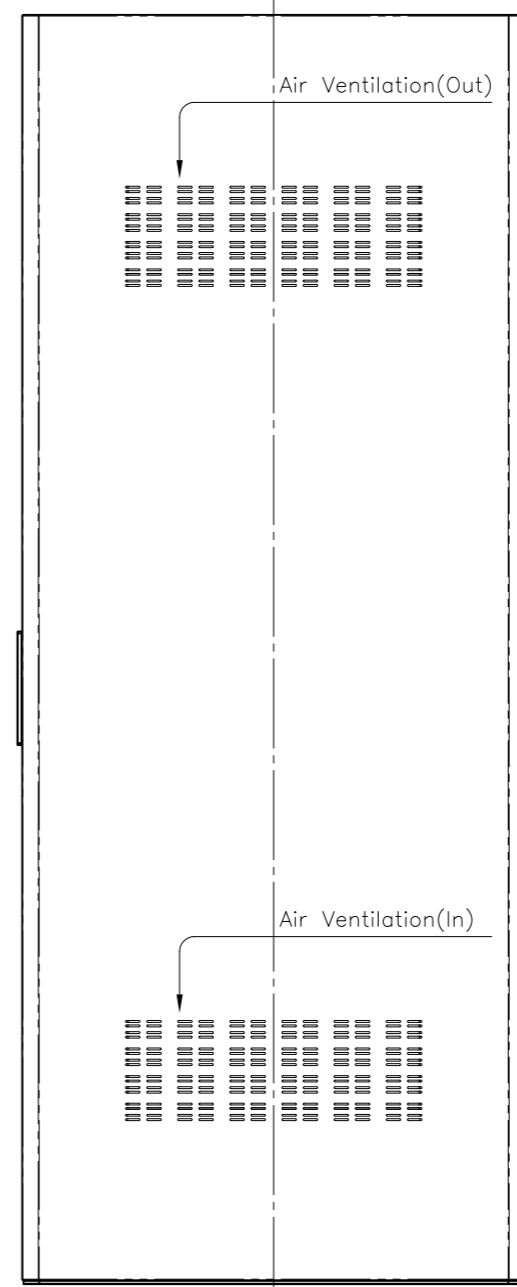
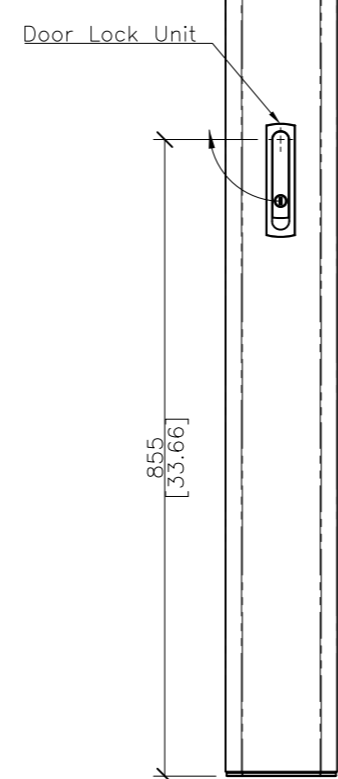
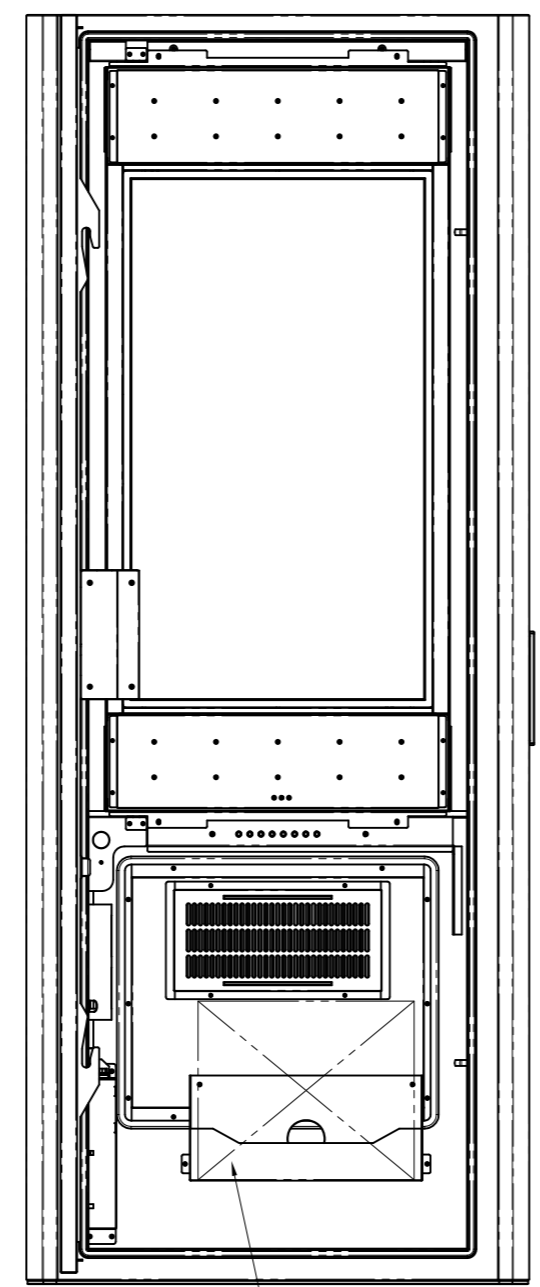
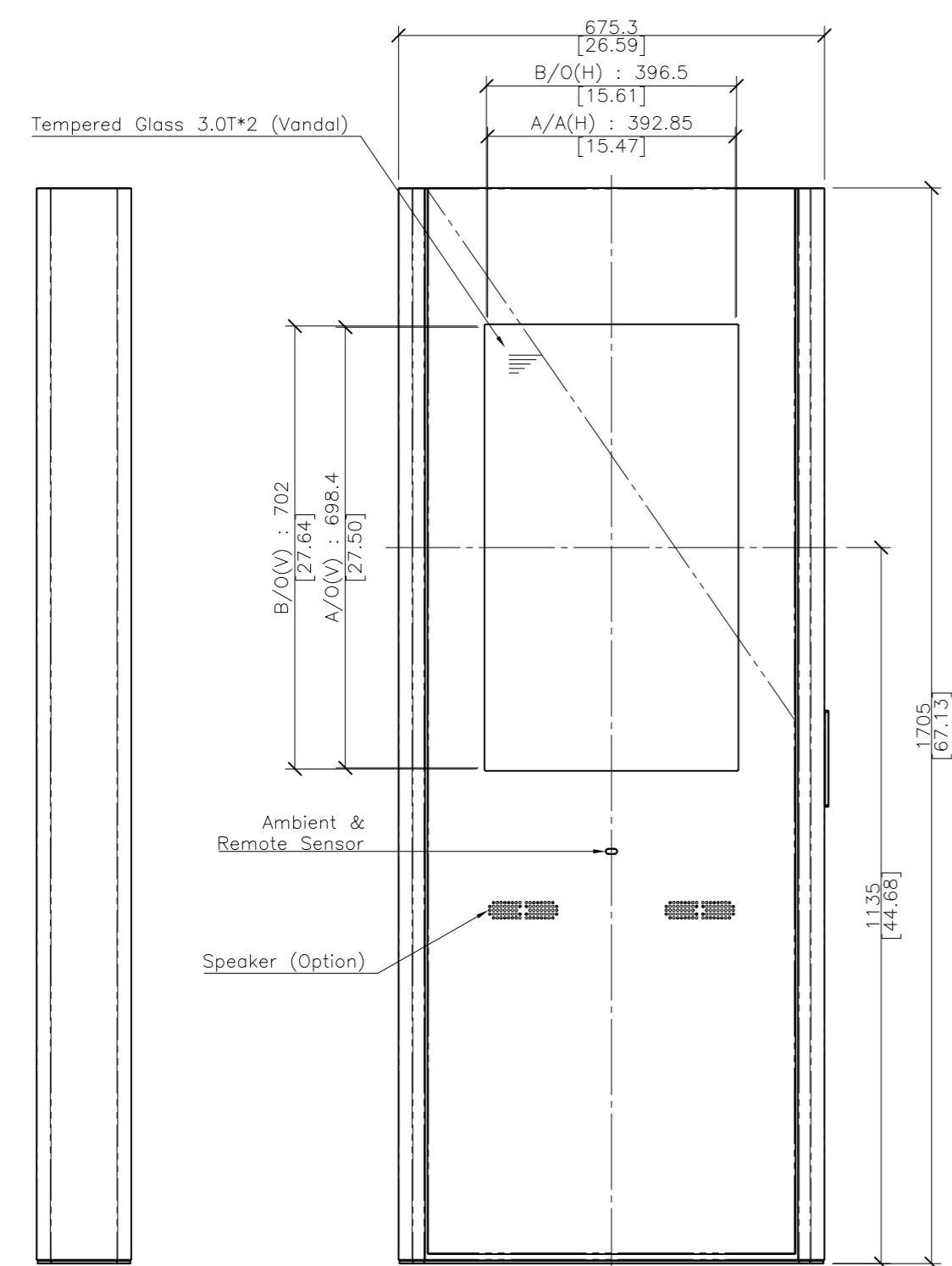
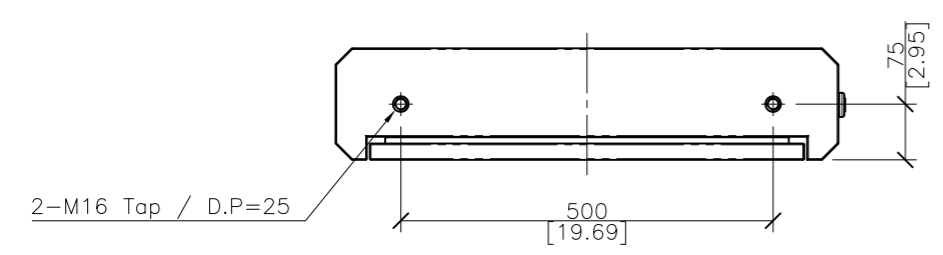
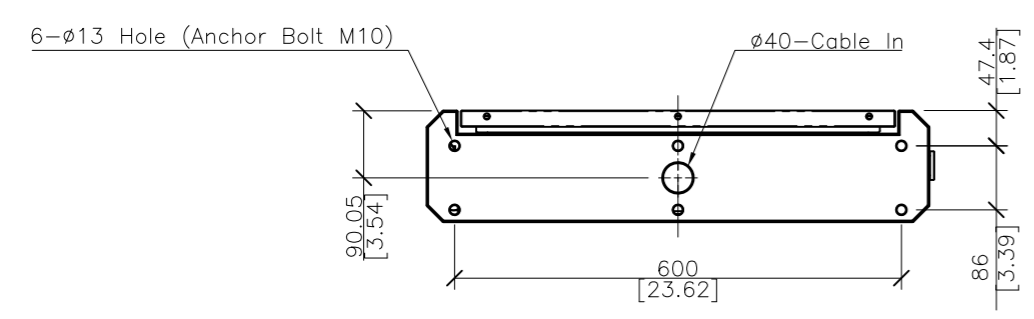

NOTES,

1. Cable Entry : Cable Gland("IP66" or more certified products should be used)

DRAWN S.W.SEO	PLANNED S.H.JANG	CHECKED S.H.JANG	APPROVED Y.T.KIM	UNLESS OTHERWISE SPECIFIED ALL DIMENSION ARE IN MILLIMETERS	ANGLE 3rd.	TITLE : H325S/H327S Series EXTERIOR VIEW	UNIT : mm
'20.03.16	'20.03.16	'20.03.16	'20.03.16	TOLERANCES ARE: LINEAR : X ± 0.20 X ± 0.1 XX ± 0.01 ANGLES : ± 0.1° RADIUS UNLESS NOTED : R 0.3	SCALE : 1/10		TYPE : ASSY
HYUNDAI IT CO., LTD.				MODEL NAME (CODE): H325S/H327S*	CUSTOMER: HDT	DWG REV : 01	SIZE : A2
				FILE NAME : LAYOUT_H325S_H327S_200316.DWG		SHT NO : 1/1	DWG(PART) NO. H325S/H327S_001

This drawing is the property of HYUNDAI IT Corp. and should not be disclosed to any third party without prior permission of HYUNDAI IT Corp..