

This drawing is the property of HYUNDAI IT CO.,LTD. and should not be disclosed to any third party without prior permission of HYUNDAI IT CO.,LTD..

A B C D E F G H I J

REV. NO		REV. HISTORY	LTR	ECO NO	DATE	APPR'L
DWG	PART					
00	00	INITIAL RELEASE	-	-	-	-

① Display

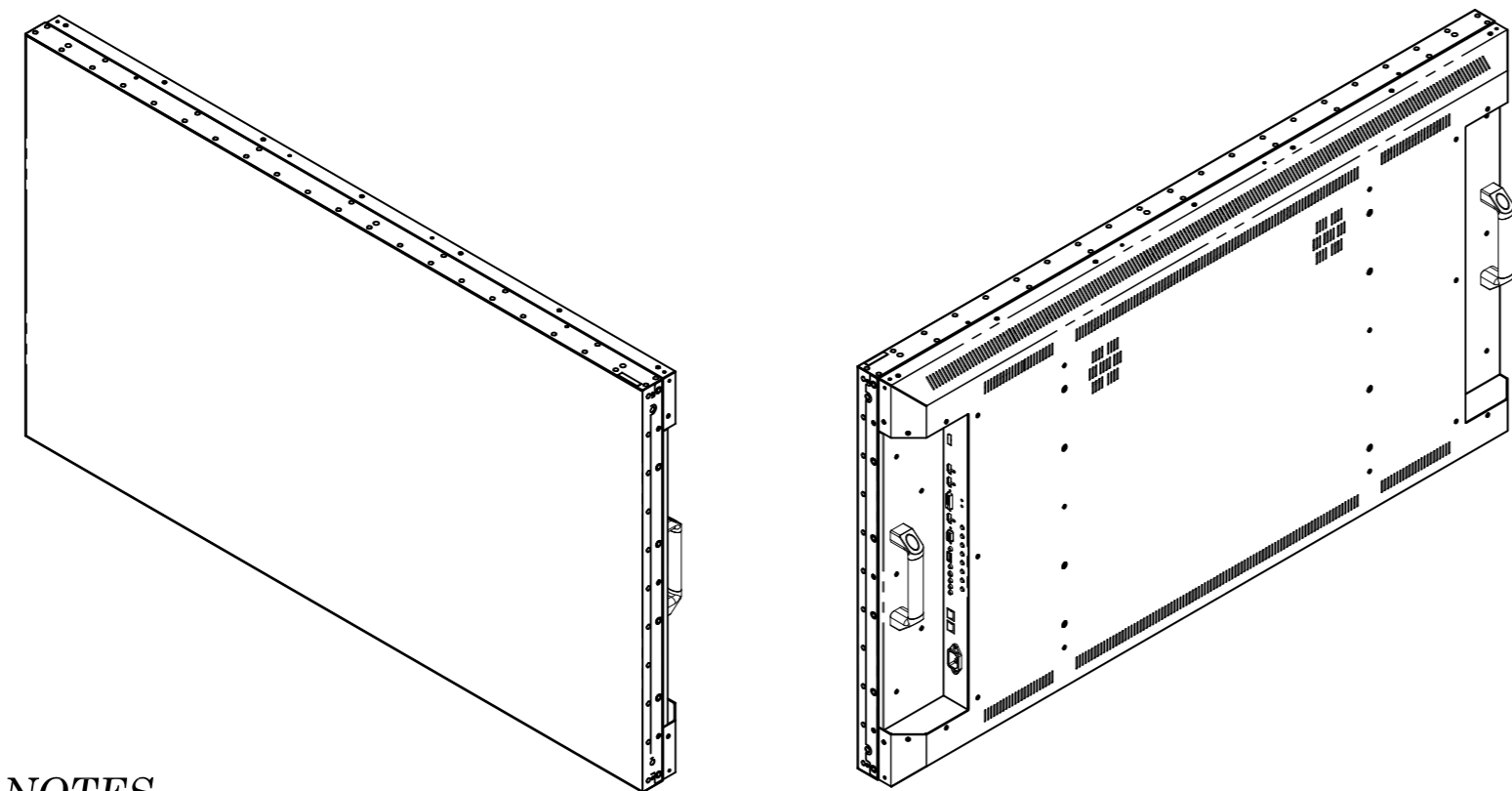
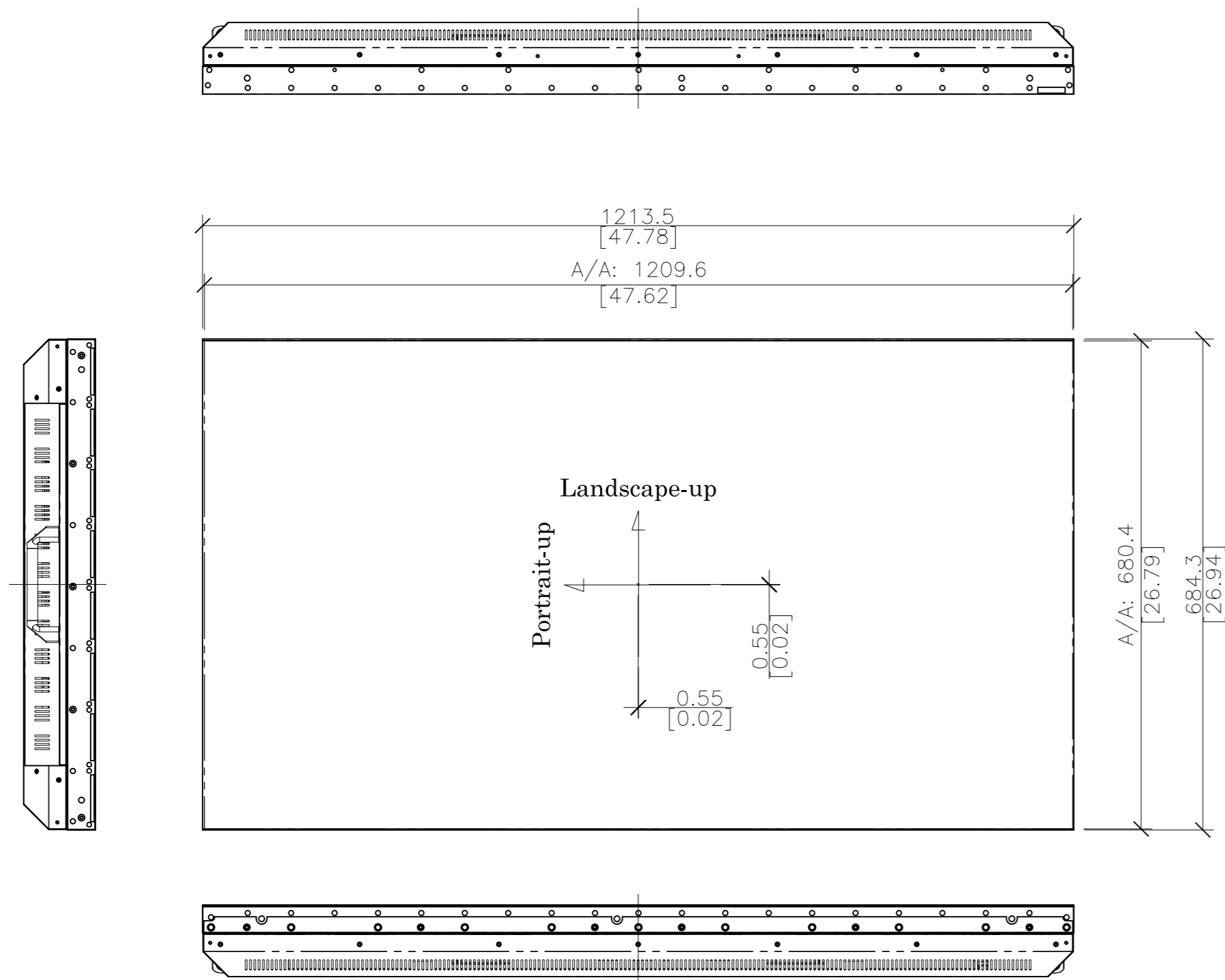

- NOTES,**
- LCD Panel : 55" UNB
  - Material : E.G.I
  - Color : Black

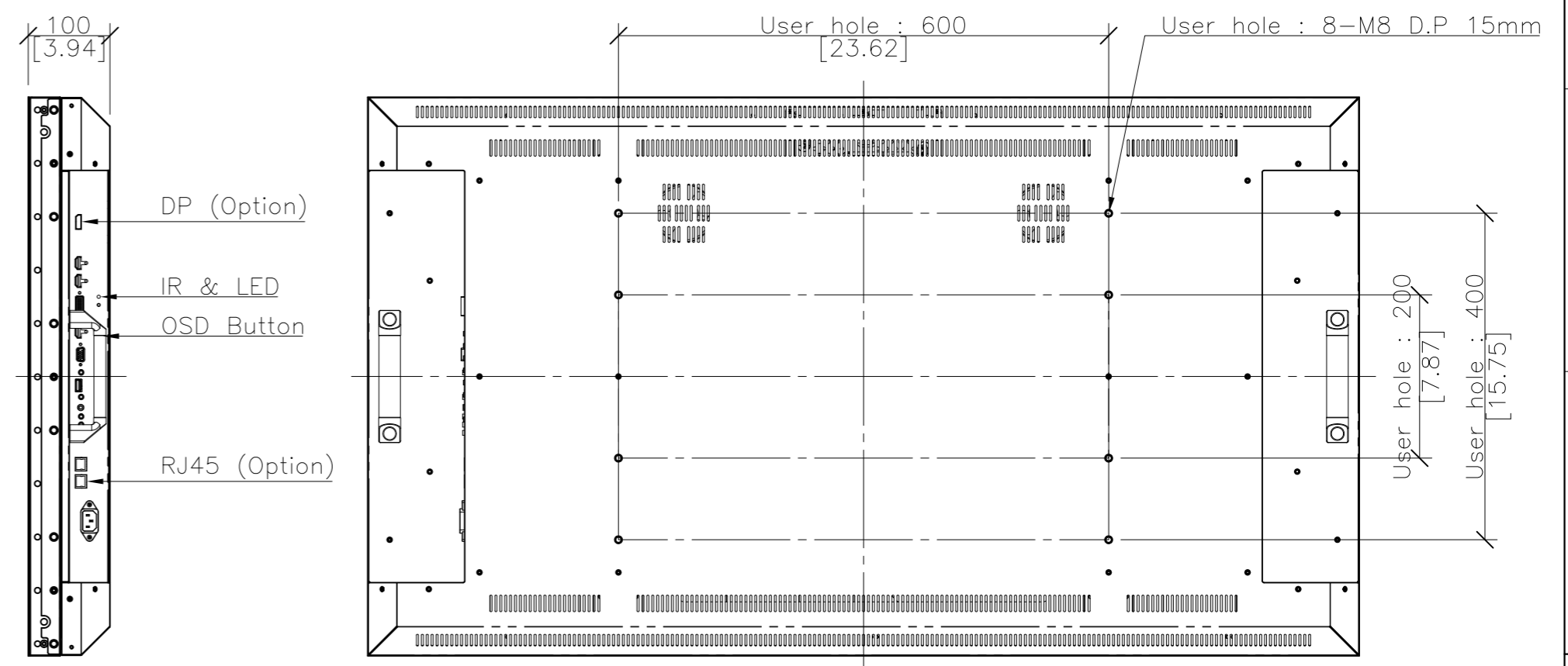

②-1 Multi Brkt Hor : 2 EA

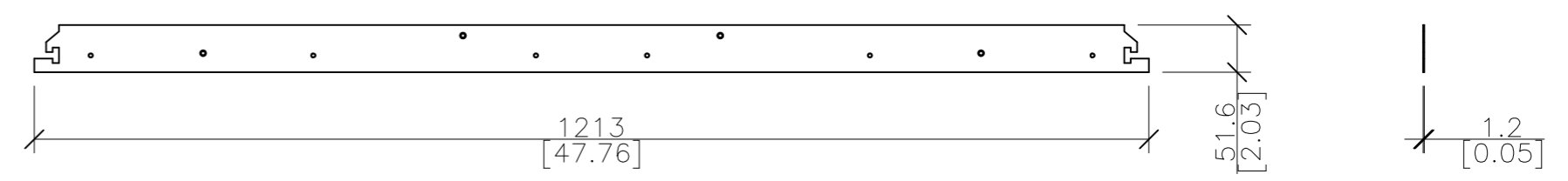

②-2 Multi Brkt Right : 1 EA

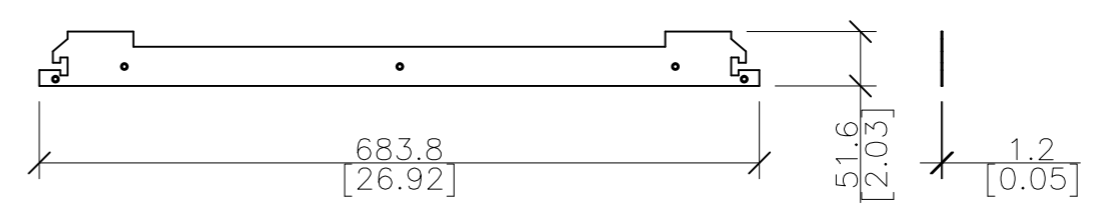

②-4 Multi Brkt Corner & Screw  
[ Brkt-2 EA / M4 Screw(L=6, 24 EA) ]

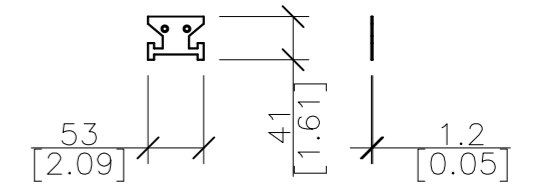

②-3 Multi Brkt Left : 1 EA

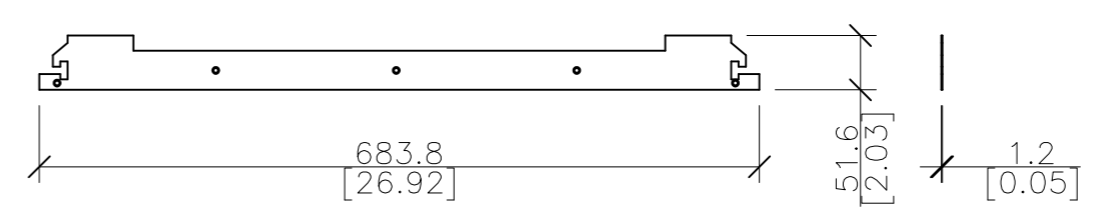

DRAWN	PLANNED	CHECKED	APPROVED	UNLESS OTHERWISE SPECIFIED ALL DIMENSION ARE IN MILLIMETERS	ANGLE 3rd.	TITLE : D55MFN(SFN) EXTERIOR VIEW	UNIT : mm
S.W.SEO	S.H.JANG	S.H.JANG	Y.T.KIM		TOLERANCES ARE : LINEAR : X ± 0.2 X ± 0.1 .XX ± 0.01 ANGLES : ± 0.1° RADII UNLESS NOTED : R 0.3		SCALE : 1/10
'18.11.21	'18.11.21	'18.11.21	'18.11.21	MODEL NAME (CODE): D55MFN(SFN) CUSTOMER: HDIT	DWG REV : 00	DWG(PART) NO. D55MFN(SFN)_001	SIZE : A3
HYUNDAI IT CO., LTD.					FILE NAME : LAYOUT_D55MF_181121.DWG		SH'T NO : 1/1